

SEPT 86. ISSUE 5.

EDITORIAL

Welcome to issue 5 of the C16/Plus 4 handbook. The good news for C16/Plus 4 owners this issue concerns recent software releases. Although quantity is still lacking there is no lack of quality around this issue. We review eight new games this issue of which two have a 'Good' overall rating, a further two have a 'Very Good' rating, three more have an 'Excellent' rating, and the other a 'Rave' rating our top mark. Of the eight games, seven run quite happily on the C16 as well as the Plus 4.

On the game hints side we have had a few more game pokes and cheats for this issue and we hope that this trend will continue. On the minus side it would be nice to receive a few more maps. Do not worry if your artwork is not brilliant, we can always tidy the maps up for the handbook, so why not put pencil to paper and show us what you can do. Thanks for your support.

FRONT COVERS

Our thanks this issue go to T McGuinness for his front cover design. If you believe you can design anything as good, then send in your designs and if we use your cover we will send you a small token of our appreciation.

ISSUE 4 SOFTWARE WINNER

A Gale of Southampton wins last issues £8 worth of Software.

WANTED YOUR ORIGINAL HINTS/MAPS/SOLUTIONS

The success of any Handbook like this relies on a cross flow of information from its readers. The more contributors the better the Handbook. We give away £8 worth of software each issue to the best contributions we receive. Even if you do not win a main £8 prize many contributors find that they receive some other small token of our thanks.

All we ask is that you send in any information you have on both the new and old games, and if we have not printed the information before we will put it into the Handbook. Please try to ensure that any hints you send are your own work and not just taken from another magazine.

We are unable to test all the hints we get so please try to ensure that there are no mistakes in the information you supply. Please ensure the following guidelines are met:

1. HINTS/SOLUTIONS: Write as neatly as possible, if at all possible type your information as our interpretation of your handwriting may sometimes lead to mistakes.

2. MAPS: Maps should be no larger than A4 size, although you can have various parts of the map on separate sheets as long as it still makes sense.

If you wish any of your Information returned please enclose a Stamp Addressed Envelope and we will return as soon as possible.

\*\*\*\*\*  
\*\*\*\*\*GENERAL NEWS AND GOSSIP\*\*\*\*\*  
\*\*\*\*\*

MORE MAGAZINES!

Two new magazines are to hit your Newsagents. "Bang" will be produced weekly at a price of 40p and will be aimed specifically at the 13 to 25 age groups. As

well as Computer information there will be items on TV, Video, Film, Books, Sport, etc. It is due for release in September and book your copy early as they are only printing an initial total of 90,000 copies!!! The other mag LM is from the Newsfield stable and is due for an Xmas release. We phoned Newsfield for some info but were told to phone Roger Garrett who was working from home. We phoned Roger only to get the dreaded answering machine. So where was the naughty man! LM will apparently contain information on similar lines to Bang so it should make an interesting contest!

SOFTWARE LOTTERY

The scratch cards are to hit the Home Computer market from the 28th July, as all new Ariolasoft titles will contain scratch cards that will feature a screen shot which has to be identified from various possibilities. If you make the correct choice you can win a free game or between £2 to £4 off the R.R.P. of one of their games or wait for it an Ariolasoft badge! Wow who needs motor cars or something as boring as a £1000.

\*\*\*\*\*  
\*\*\*\*\*SOFTWARE NEWS AND GOSSIP\*\*\*\*\*  
\*\*\*\*\*

PAPERBOY DELIVERY CONFIRMED

The delivery of the long awaited Elite Arcade conversion Paperboy has been confirmed for the 15th September 1986. It is due initially for the Spectrum and C64 with the Amstrad, BBC, and C16 versions following at weekly intervals.

\*\*\*\*\*  
\*\*\*\*\*READERS SECTION\*\*\*\*\*  
\*\*\*\*\*

GAME HELP WANTED

A Steele of 7 Trafford Close, Leek, Staffs, SM3 5BG wants to know how to complete Catacombs.

D Sicklenore of 25, Carlton Gardens, Norwich, needs a poke to be able to run 'Las Vegas Jackpot' on his Plus 4.

F Bissett of 50, Chelmsford Rd, Southgate, London, N14 5PT needs to know how to tackle the dragon in the North Tower in 'Twin Kingdom Valley'.

C Milton of 4, Milton drive, Buckie, Banffshire, AB5 1NW has a problem in 'Out on a Limb'. After climbing the beanshoot Jack has to jump on each cloud. He can get him to jump to the extreme left cloud and then onto the next and onto the large middle one, then onto the extreme right one, but cannot get him to jump on either of the highest clouds. When he tries to jump on them he just lands on the lower ones. Can anyone help?

HIGH SCORES

The following high scores have been sent in:

D Watson, Andover:  
Xargon Wars 1000, Formula 1 Simulator 256310.

L Bennie, East Lothian:  
Kik Start 31589, Manic Miner 6452, Xargon Wars 851.

## TECHNICAL HELP WANTED

Mr Jakes of 25 Ridge Hill, Tiverdale, W Midlands is trying to do a back up copy of A.C.E. but is having a little trouble. Does anyone know how to re-enable the reset button after it has been disabled by commercial software?

R Jones of 27, Landseer ave, Warrington, Cheshire, WA4 6DH wants to expand his Plus 4 in to a full computer system with Disc Drive, Printer and perhaps a Modem. Does anyone know the best way of getting hold of these items that are compatible with the Plus 4.

S Longland of 2, Sparrowhill Cottages, Waterend lane, Wheathampstead, Herts, AL4 8EP has found it very difficult to obtain any information about the Plus 4's built in software and equipment available for the machine. Commodore UK have not been very helpful and would ask if any readers can advise him of any publications for the Plus 4 which cover aspects other than Basic programming, and outline the full potential of the computer.

C Archer of 4 Crosslane West, Partington, Urmston, M31 4ET wants to get more out of his Plus 4. Can anyone advise any suitable literature that may be of interest to him.

## FOR SALE

A Mushtaq of 63 St Pauls Rd, Foleshill, Coventry, CV6 5DE has the following games for sale:

Tom Thumb £5, Airwolf £4.50, Runner £1.

## PEN PAL WANTED

Darren Fox of 70, Southdown crescent, Sth Harrow, Middx, HA2 0QS wants pen pals. He owns a C16 and hopes to correspond with fellow C16/Plus 4 owners.

## HELP OFFERED

In response to a plea for help from G Higgins concerning the availability of a Plus 4 Programmers Guide. Mr G Payne claims that the book is available from branches of W.H. Smith and is titled 'Programmers Reference Guide for the Plus 4' by Cyndie Morten, and Sarah Mayer, published by Scott Foresham. It is priced at a hefty £16!

## READER FEEDBACK

L.L. Bennie of East Lothian had the following two comments:

I was annoyed to see in the C16/Plus 4 handbook No 4 that the game "Mercenary" was given over nine pages to itself. A lot of the information had already been printed in Aprils Commodore User.

Whilst browsing through your Pre-Order scheme list I was pleased to see that Jet set Willy II and Who Dares Wins II were soon available for the C16. That is until I saw that Tynesoft were doing the conversions. Why can they do this. I always thought that Software Projects and Alligata produced these games for other computers. I suppose they will make the usual bad job, just as every other Tynesoft game.

## H&amp;D COMMENT

Firstly we were the first to produce Mercenary information in our C64 handbook earlier this year and the information followed in other computer mags. Why

should we deny our Plus 4 readers the benefit as soon as the Plus 4 version appeared, which is exactly what we did. Hope you like this issues Second City help.

Reference to Tynesoft. Without Tynesoft being willing to take on the license to these two games it is doubtful whether they would have appeared at all. We have no real love for Tynesoft but their Jet Set Willy conversion was as good as could be expected, so there is no reason why Tynesoft should not also produce good conversions for other games.

## READERS TOP TEN

We list the Top Tens some of our readers have sent us:

L Bennie, East Lothian:

1. Kikstart 2. Manic Miner 3. Formula 1 Simulator 4. Out on a Limb 5. Berks 6. Dorks Dilemma 7. Big Mac 8. Xargon Wars 9. Hustler 10. Kung Fu Kid.

D Watson, Andover:

1. Steve Davies Snooker 2.A.C.E. 3. Formula 1 Simulator 4. Space Pilot 5. Commando 6. Sky Hawk 7. Rockman 8. World Cup Football 9. BMX Racers 10. World Series Baseball

F Bisset, London:

1. Tom Thumb 2. Twin Kingdom Valley 3. Jack Attack 4. The Exploits of Fingers Malone 5. Bandits at Zero 6. Timeslip 7. Icicle Works 8. Sorcerer of Claymorgue Castle 9. Big Mac 10. Dorks Dilemma

J Hatton, Leicester:

1. Tom Thumb 2. Squirm 3. Exorcist 4. Ten Little Indians 5. Circus 6. Sorcerer of Claymorgue Castle 7. Tutti Frutti 8. Blagger 9. Mr Puniverse

A Steele, Leek:

1. Speed King 2. Bongo 3. Kik Start 4. Sword of Destiny 5. The Boss 6. A.C.E. 7. Games Pack II 8. Games Pack I 9. Mr Puniverse 10. Oblido

A Steele has also kindly sent in his Bottom Ten:

1. Catacombs 2. Olympiad 3. Slippery Sid 4. Pizza Pete 5. Rig Attack 6. Commando 7. Galaxions 8. Games Pack II (We thought this was in his Top Ten ?) 9. Return of Rockman 10. Airwolf

## ADVENTURE HELP OFFERED

J Barnsley of 32 Merrivale Rd, Rising Brook, Stafford, ST17 9EB. (Tel: Stafford 56723) offers help on the following: (Please enclose S.A.E.)

ALL LEVEL 9, ALL INTERCEPTOR, ALL CHANNEL 8, ALL SCOTT ADAMS (EXCEPT RETURN TO PIRATE ISLAND), SUBSUNK, HEROES OF KHAN, EMPIRE OF KHAN, TERRORMOLINOS, JEWELS OF BABYLON, MORDONS QUEST, CRYSTALS OF CARUS, NEVER ENDING STORY, MINDSHADOW, VALHALLA, URBAN UPSTART, ROBIN OF SHERWOOD, HAMPSTEAD, LORD OF THE RINGS, GREMLINS, ZZZZ, VALKYRIE 17, BORED OF THE RINGS, QUEST FOR HOLY GRAIL, SEABASE DELTA, VERY BIG CAVE ADVENTURE, PETER PAN, ZORK 1, RING OF POWER, DALLAS QUEST, PERRY MASON AND THE MANDARIN MURDER, TRACER SANCTION, AZTEC TOMB PARTS 1 AND 2, HULK, SPIDERMAN, EUREKA, CASTLE OF TERROR, KET TRILOGY, TWIN KINGDOM VALLEY, PEN AND THE DARK, CASTLE BLACKSTAR, SEAS OF BLOOD, KENTILLA, PUB QUEST, BEATLE QUEST, REDHAWK, VELNORS LAIR, CATACOMBS, FOURTH PROTOCOL, SEE-KAA OF ASSIAH.

\*\*\*\*\*  
 \*\*\*\*\*GAME PLAYING HINTS SECTION\*\*\*\*\*  
 \*\*\*\*\*

GAME PLAYING HINTS THIS ISSUE H=HINTS, P=POKES, M=MAPS, S=SOLUTIONS.

BANDITS AT ZERO P, BERKS P, BIG MAC P, BLAGGER H, BOOTY P, COMMANDO P, DALEY THOMPSONS SUPER TEST H,P, GHOST CHASER H, KIK START P, MR PUNIVERSE P, OBLIDO P, RETURN OF ROCKMAN P, ROBIN TO THE RESCUE P, ROCKMAN P, SECOND CITY H,M, SQUIRM P, STARTER CHESS C16 H, SWORD OF DESTINY P, TOMB THUMB H, TUTTI FRUTTI P, TWIN KINGDOM VALLEY H, XARGON WARS P, ZORK 1 H, ZORK 2 S,M.

#### BANDITS AT ZERO

Load and reset then enter:

1 POKE 11100,96 (To become bullet proof)

SYS 1384 to start.

#### BERKS

Load and reset then enter:

1 POKE 4467,255 (For approx 60 extra lives)

SYS 4080 (to restart)

#### BIG MAC

Load and reset then enter:

POKE 12691,n (Where n= No of lives 0-255)

SYS 7000 to Restart

#### BLAGGER

In this game pressing F1 aborts the game.

#### BOOTY

Load and reset then enter:

1 POKE 1396,96 (Stops pirates killing)

2 POKE 10368,96 (Stops pirates appearing)

3 POKE 8865,96 (Closes trap doors)

4 POKE 6068,96 (Start game with same amount of booty left last game)

SYS 4112 to start.

#### COMMANDO

Load and reset then enter:

1 POKE 5717,n (Where n= No of lives 0-255)

or

2 POKE 11495,185 (Makes you invincible)

SYS 4109 to start.

#### DALEY THOMPSONS SUPER TEST

For Side 2 Select key 'K', to run hold down 'Y' and press 'Q' fast.

Break into Program (Run/Stop & Reset) Type:

A 29CF BEQ\$29D1

To run again G 2437

On the Long Jump all you need to get a record jump is to:

1. Place your finger on the fire button and keep it there.
2. Start wagging like mad.
3. You will automatically jump near the line and all you have to do is remove your finger when near 45 degrees.

#### GHOST CHASER

When you start the game type in 'Fanda' and you will go into the second part of the game.

#### KIK START

Load and reset then enter:

1 POKE 9796,n (Where n= No of lives 0-255)

SYS 8192 to start.

A word of warning. If you choose 255 lives and you gain an extra one you go to 1 life but gain a large bonus.

or

When the game has loaded, break into the program (Run/Stop & Reset) to get Monitor.

Type in: M23E8 and change B1 to BF. Press Return.

Move the cursor to the bottom of the screen and type G2000 and press Return to play Kikstart.

This will make the bike fly over all 16 courses and you can still accelerate, decelerate, and jump, but beware of clouds and flying stars on later courses.

If you change the B1 to BD the bike goes a little lower on the screen.

#### MR PUNIVERSE

Load and reset then enter:

1 POKE 12870,n (Where n= No of lives 0-255)

2 POKE 8562,58 (To walk through walls)

SYS 6900 to start.

or

Break into the game (Run/Stop & Reset)

To walk through all objects except cubes, Type:

A 25F9 JSR\$0600

A 25FC BPL\$2608

- A 0600 LDA#500
- A 0602 STAS4B
- A 0604 STAS4C
- A 0606 RTS

To run again GLAF4

OBLIDO

Load and reset then enter:

- 1 POKE 8060,160: POKE 8061,57: POKE 8062,234 (For extra time)
- 2 POKE 5605,96 (To keep sins in sin bin)
- 3 POKE 6066,00 (To stop sins shooting)
- 4 POKE 4673,1 (To go through walls)

SYS 4200 to start.

RETURN OF ROCKMAN

These are pokes instead of having to enter the memory.

Load and Reset then enter:

- 1 POKE 4116,n (Where n=No of lives 0-255)
- 2 POKE 4135,n (Where n=No of required level 0-9)

SYS 4112 (to restart)

ROBIN TO THE RESCUE

Load and reset then enter:

- 1 POKE 7203,n (Where n= No of keys to collect 0-5)
- 2 POKE 5936,96 (Clears men with spears)
- 3 POKE 7680,96 (Clears rocks)
- 4 POKE 6499,96 (Clears arrows)

SYS 4112 to start.

ROCKMAN

Load and reset then enter:

- 1 POKE 9757,n (where n = No of lives 0-255)
- or
- 1 POKE 7409,173 (Disables monsters)

SYS 7367 to start.

THE SECOND CITY

The following hints and maps have been compiled by D Foulkes and deliberately do not contain all the information so as not to spoil the game totally. The whereabouts of the keys and all the objects needed to complete the game are not included. The triangle key has been deliberately ignored as finding this key does make the game fairly simple to complete.

LOCATIONS OF ELEVATORS

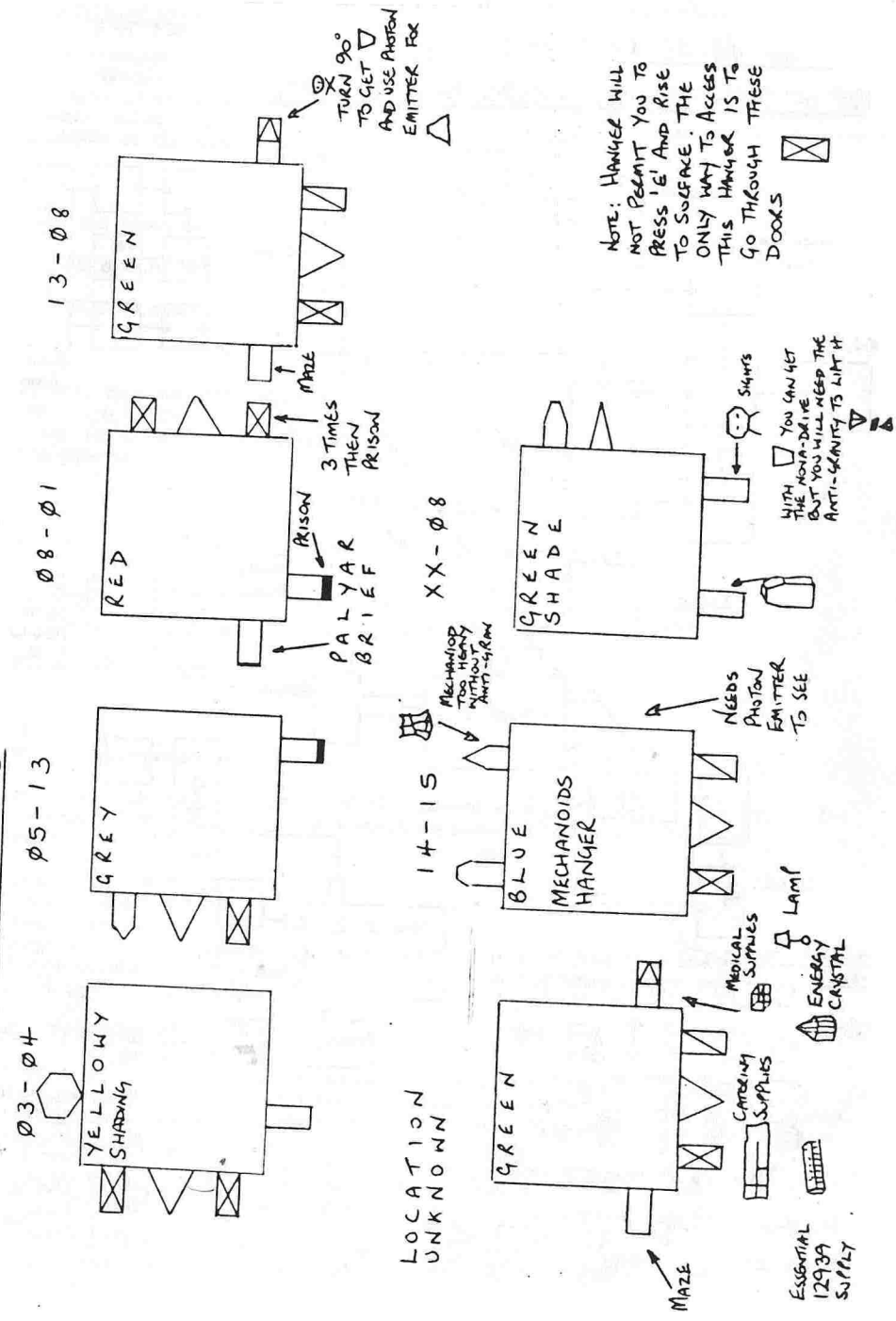

LOCATION 08-08 AT 65,000 FT CONT.

SHEET No 2

MAP OF COLONY CRAFT WITH ROOMS MARKED FOR EASE OF USE.

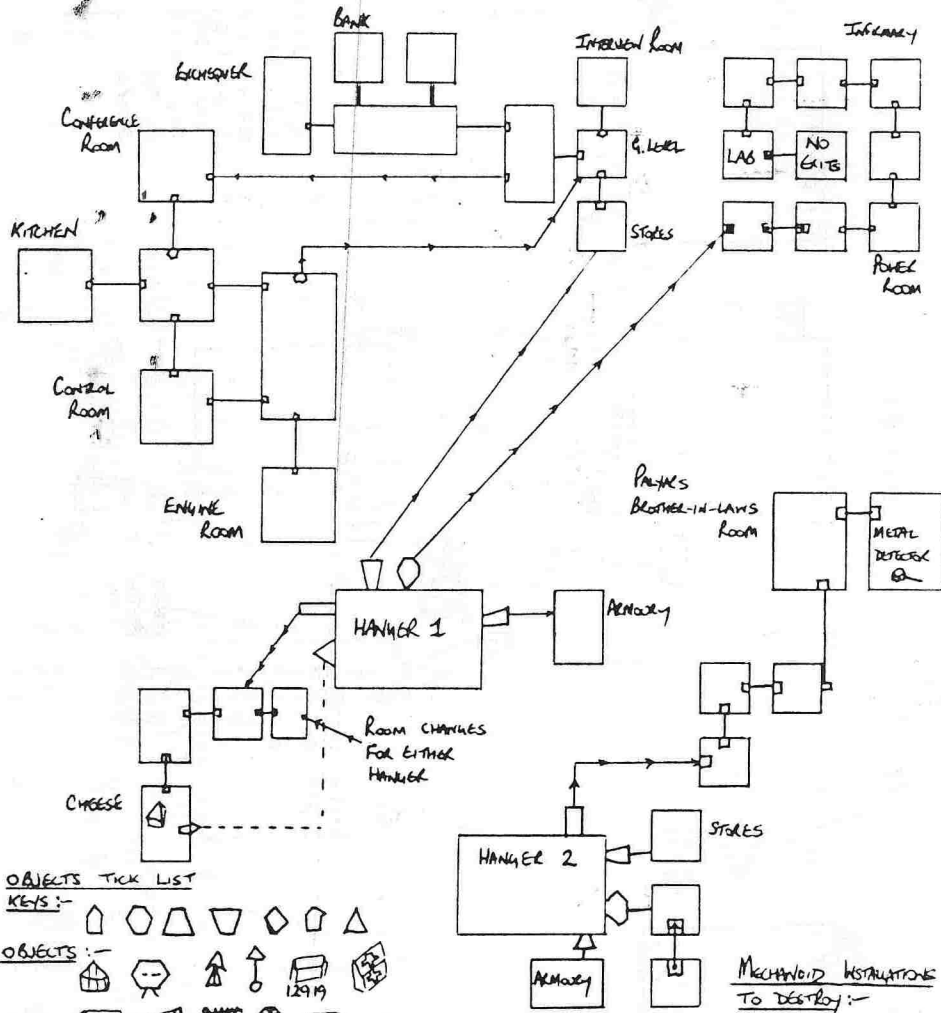

OBJECTS TICK LIST

- KEYS:-
- - 
  - △
  - ▽
  - ◇
  - ⬆
  - ⬇
  - ⬇
  - ⬆
- OBJECTS:-
- ⊠
  - ⊡
  - ⊢
  - ⊣
  - ⊤
  - ⊥
  - ⊦
  - ⊧
  - ⊨
  - ⊩
  - ⊪
  - ⊫
  - ⊬
  - ⊭
  - ⊮
  - ⊯
  - ⊰
  - ⊱
  - ⊲
  - ⊳
  - ⊴
  - ⊵
  - ⊶
  - ⊷
  - ⊸
  - ⊹
  - ⊺
  - ⊻
  - ⊼
  - ⊽
  - ⊾
  - ⊿
- XX-08    03-04    14-15    08-08 65,000 FT    08-08

MECHANOID ILLUSTRATIONS TO DESTROY:-

- 01-01 VECTOR HEDGE
  - 03-14 TYLER POINT
  - 14-01. MECHANOID FOOT
- NOVA BALL } CAN YOU  
MORDOS ARCH } FIND  
-- CUBE } THESE ?

LOCATION AT 65000 FEET 08-08

This location is the Palyar colony craft. In the hanger you will encounter a problem, namely your ship and anything else you have in the hanger will disappear, if you enter a certain room. Momentarily however going into any of the  $\Delta$   $\nabla$  key rooms will restore your ship and the contents of the hanger to their rightful place.

SQUIRM

Load and reset then enter:

1 POKE 9446,n (Where n= No of lives 0-255)

SYS 9220 to start.

STARTER CHESS C16

Firstly type MONITOR and press Return. Then type L "Chess" and press Return. After the game has loaded and the flashing cursor appears type G2000. The game will now play.

SWORD OF DESTINY

For no Aliens: Break into Program (Run/Stop & Reset) Type:

- A 3D26 RTS
- or, and
- A 3EC8 NOP (Cannot die if no power left)

To run again G 3E0E

TOM THUMB

Keyboard Alterations:

It is possible to use a number of alternative keys for direction etc. Pick the combination that suits you. This works on a Plus 4 but we are unsure as to its working on a C16.

Left: £ Ctrl A D G J L ;

Right: 2 4 6 8 0 help

Down: I return

Jump: 9 V Inst/Del (only if using a direction return- This is a low jump- ideal for negotiating spiders over water, or other low obstacles.

Extra Speed: V shift

GENERAL HINTS

Always use extra speed as this makes it more easy to clear the objects. Once you have lost all your lives just press return and you will start again from where you died, this makes it easier to cover a great deal of ground in one sitting.

All creatures follow a set pattern so to get past one just let it run until you know its pattern then take the appropriate action.

All Lazer beams and arches go on and off at the same intervals so just watch and wait.

Small blue creatures are unpredictable. Using a low jump when they appear is usually the best bet. If they lurk at the top of the ladder then you've had it, there is no way of avoiding them.

TUTTI FRUTTI

1 POKE 10534,n (Where n= No of lives 0-255)

SYS 8192 to start.

If the continual music drives you potty to turn it off put on your Shift Lock key.

or

When the game has loaded break into the program (Run/Stop & Reset) to get the Monitor.

Then type 1F06 and change A5 to A4. Then move cursor down to bottom of screen and type G2000 press Return and Fire.

This will give you infinite lives and instead of eating the fruit you must kill the Acid Apple Gang to get on to the next level, and on level 3 the blocks containing cherries turn into cherries but still kill the Acid Apple gang.

TWIN KINGDOM VALLEY

For the ability to see concealed entrances take a drink at the Watersmeet in the canyon.

Always ask elves for any equipment they are carrying and they will do as you ask.

If you have to fight your way out of a situation always cut an opponent as if you hit him you will invariably drop the weapon.

XARGON WARS

Load, then enter the following and Run:

1 POKE 7302,n (Where n= No of lives 0-255)

ZORK I

To go underground remove the carpet to reveal a trap door.

In the cave dig 4 times to reveal a treasure.

To inflate the dinghy you need a pump.

Use the Gunk to repair the leak in the Dam control room.

To get past the Cyclops feed him something hot.

The Cyclops could also do with a drink of water.

Short of treasure! try the Buoy.

To enter Hades you need the bell, book, and candle.

Take care of the lamp as it will eventually run out and cannot be re-lit. However other sources of light are available.

To return from the underground try praying at the altar.

The sceptre can be used at a colourful location to provide a bridge.

The grating can only be opened from below.

To open the resevoir you need the wrench and to press a few buttons (except the blue!). Turn the bolt with the wrench and everything should run smoothly.

ZORK 2

COMPLETE SOLUTION (M Stuckey)

At start, in the tunnel; TAKE ALL, LIGHT LAMP (turn off lamp whenever you get to daylight), S, S, S, SW, S, SE, ENTER GAZEBO, TAKE TEAPOT, OUT, N, NE, GET WATER

ZORK II

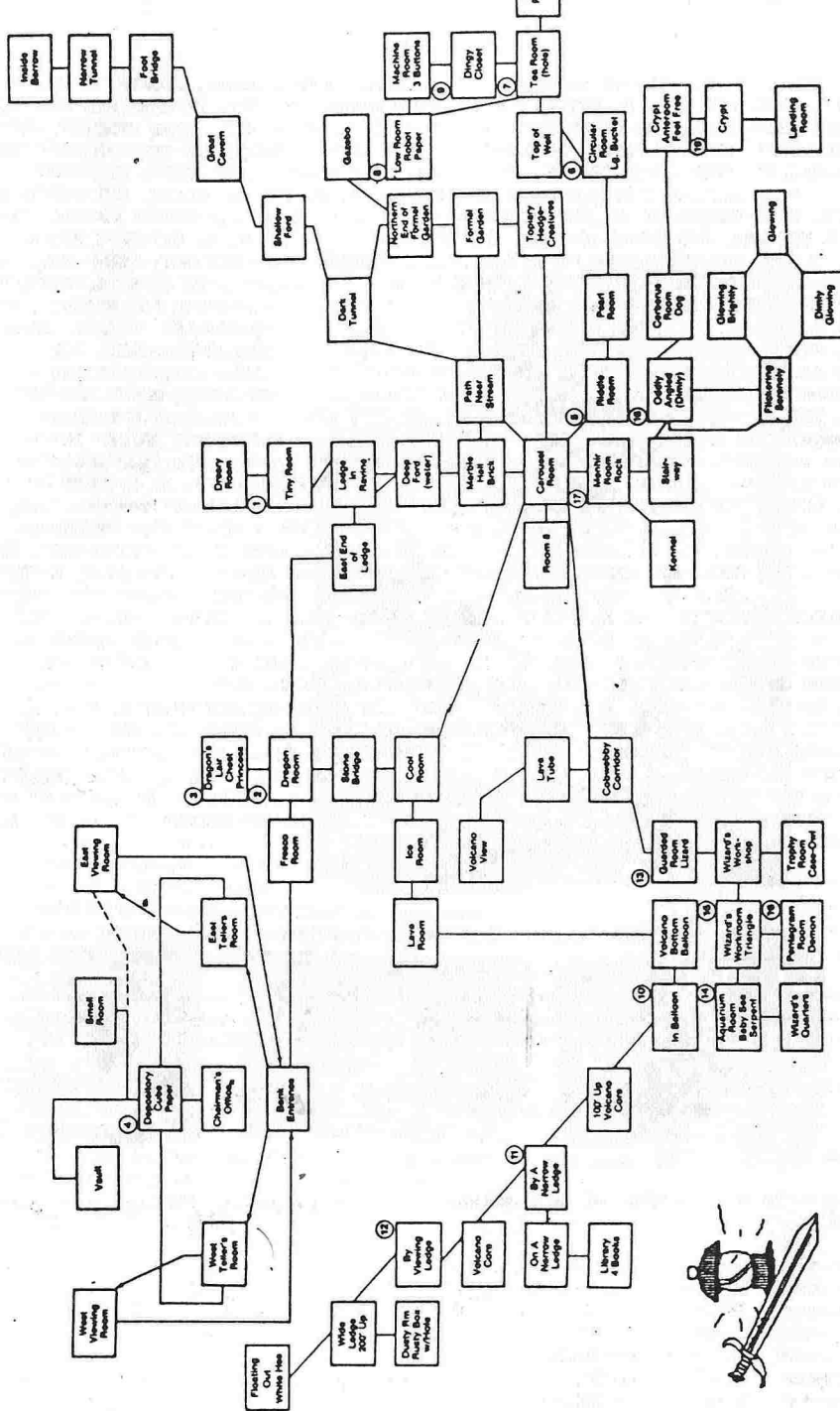

S, SE, S, S, W, SE(keep exiting till you reach Riddle Room), ANSWER "A WELL", E, GET PEARL NECKLACE, E, GET IN BUCKET, POUR WATER, GET OUT, E, TAKE RED AND BLUE AND GREEN CAKES, EAT GREEN CAKE, E, THROW RED CAKE IN POOL, TAKE CANDIES, W, EAT BLUE CAKE, NW, GET PAPER, READ PAPER, TELL ROBOT "E", E, TELL ROBOT "PUSH TRIANGLE", TELL ROBOT "S", S, GET SPHERE, TELL ROBOT "LIFT CAGE", GET SPHERE, N, W, S(keep exiting till you reach the Tea Room), W, GET IN BUCKET, GET WATER, GET OUT, DROP TEAPOT, W, W, NW, OPEN BOX, GET VIOLIN, E, N, N, ENTER GAZEBO, DROP ALL BUT LAMP AND SWORD, GET MAT AND OPENER OUT, S, S, W, N, GET CLAY BRICK, N, N, U, PUT MAT UNDER DOOR, OPEN LID, PUT OPENER IN HOLE, GET MAT, GET KEY, GET OPENER, UNLOCK DOOR WITH KEY, OPEN DOOR, N, GET SPHERE, S, D, S, S, S, E, N, N, ENTER GAZEBO, DROP ALL BUT LAMP SWORD AND BRICK, GET NEWSPAPER AND MATCHES, OUT, S, S, W, SW, GET BLACK STRING, N, D, E, N, N, ATTACK DRAGON, S, ATTACK DRAGON, S, ATTACK DRAGON, W, W, GET RUBY, S, GET IN BASKET, OPEN RECEPTACLE, PUT PAPER IN RECEPTACLE, LIGHT MATCH, LIGHT PAPER WITH MATCH, WAIT, WAIT, LAND(at small ledge), TIE WIRE TO HOOK, GET OUT, GET ZORKMID, S, OPEN PURPLE BOOK, GET STAMP, N, GET IN BASKET, UNTIE WIRE, BURN PAPER, WAIT, WAIT, WAIT, WAIT, LAND(at wide ledge), TIE WIRE TO HOOK, GET OUT, S, PUT STRING ON BRICK, PUT BRICK IN HOLE.( Its wise to save here due to the random selections in the game, you could die in the very near future!), LIGHT MATCH, LIGHT STRING WITH MATCH, N, S, GET CROWN, N, GET IN, UNTIE WIRE, CLOSE RECEPTACLE, WAIT(until basket reaches volcano bottom), GET OUT, N, E, E, SE, E, N, N, ENTER GAZEBO, WAIT( for Princess to enter), WAIT( for Princess to give you golden key), OPEN CHEST, GET DRAGON, DROP CHEST AND ROSE, GET CANDY RED SPHERE BLUE SPHERE AND PEARLS, OUT, S, S, W, S, S, D, S, TAKE CLUB, SE, NE, NW, SW, N, U, N, N, SW, SW, FEED CANDY TO LIZARD, UNLOCK DOOR WITH GOLD KEY, OPEN DOOR, S, W, DROP ALL BUT LAMP, E, N, N, NE, N, N, N, W, N, W, W, NE, E, S, GET PORTRAIT, N, ENTER LIGHT, ENTER SOUTH WALL, ENTER LIGHT, GET BILLS, KILL ME(!!), W, W, W, GET LAMP, S, S, S, SW, S, SE, ENTER GAZEBO, GET VIOLIN RUBY ZORKMID STAMP AND CROWN, OUT, S, S, W, SW, SW, S, W, DROP ALL BUT LAMP, GET CLUB, W, THROW CLUB AT GLASS, GET WHITE SPHERE, E, PUT WHITE SPHERE ON DIAMOND STAND, PUT RED SPHERE ON RUBY STAND, PUT BLUE SPHERE ON SAPPHIRE STAND, GET BLACK SPHERE, S, PUT SPHERE IN CIRCLE, N, GET RUBY ZORKMID STAMP AND VIOLIN, S, GIVE ALL BUT LAMP TO DEMON, N, TAKE ALL, S, GIVE ALL BUT LAMP TO DEMON, TELL DEMON "KILL WIZARD", GET WAND, N, E, N, N, NE, S, POINT WAND AT MENHIR, SAY "FLOAT", SW, GET COLLAR, NE, S, D, D, PUT COLLAR ON DOG, E, OPEN DOOR, S, TURN OFF LAMP, OPEN SECRET DOOR, S . . . . .

ACKNOWLEDGEMENTS

Our thanks to everyone who sent in their contributions that appear in this issue of the Handbook.

\*\*\*\*\*  
 \*\*\*\*\***GAME REVIEW SECTION**\*\*\*\*\*  
 \*\*\*\*\*

Each issue we look at the latest C16/Plus 4 software releases and award percentage marks against set criteria.

THE SCORING SYSTEM

The marks are awarded out of a maximum 100%. The percentage ratings are listed below.

- Between 90-100% (H&D RAVE)
- Between 80-89% (EXCELLENT)
- Between 70-79% (VERY GOOD)
- Between 60-69% (GOOD)
- Between 50-59% (AVERAGE)
- Between 40-49% (POOR)
- Between 30-39% (RUBBISH)
- Between 00-29% (A LOAD OF #&\$!)

Title Monty on the Run  
 Publisher Gremlin  
 Address Alpha house, 10 Carver St, Sheffield, S1 4FS  
 R.R.P. 6.95  
 Game type Arcade Platform

Monty Mole makes his long awaited debut on the C16/Plus 4. On the more popular machines this game title was the third in a trilogy featuring the young rascal. Monty made T.V. news back during the Miners strike of 84/85 as his mining exploits featured Mr Scargill. The game was 'nt bad either!

Anyway Monty on the Run picks up from where Monty has escaped from prison and has now to make his way through many screens to collect gold coins which will enable him to buy his freedom.

The game is made up of 30 brilliantly animated screens each with their own seemingly impossible obstacles to pass, But believe us where there is a will there is a way. The on screen animation is without doubt probably the best ever seen on this machine and all credit to Gremlin who graphically at least have matched their C64, Spectrum, and Amstrad versions.

If you enjoy a good arcade platform game of the ilk of say a Manic Miner or a

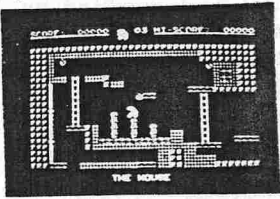
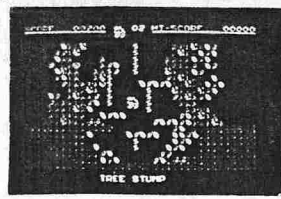
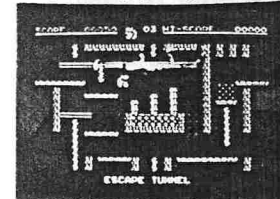
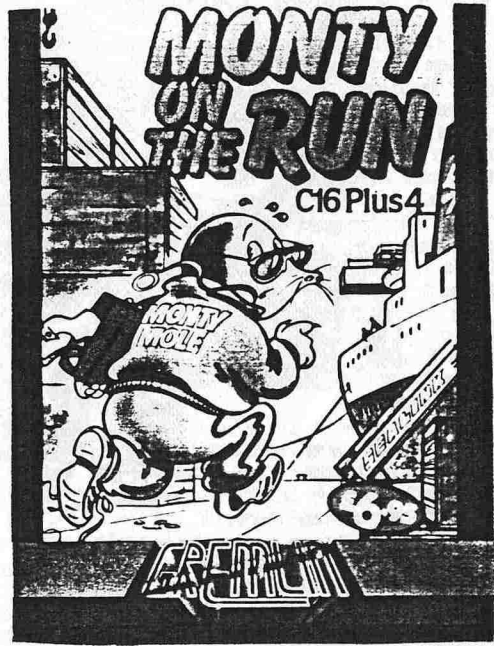

Blogger then this is for you. Possibly a contender for the best C16/Plus 4 game to date and certainly worth a £6.95 price tag.

MONTY ON THE RUN THE SCORES

GRAPHICS	92%
PLAYABILITY	94%
ADDICTIVENESS	91%
LASTABILITY	92%
VALUE FOR MONEY	92%
H&D RATING	92%



Title Matrix and Laserzone  
 Publisher Ariolasoft  
 Address 68, Long Acre, London,  
 WC2E 9JH.  
 R.R.P. 6.95  
 Game Type Arcade

Here we have two best selling C64 games converted for the C16/Plus 4. Both come from a man called Jeff Minter who produced some of the best early software for the C64.

Both games are set on grids and in Matrix you control a ship that can move left and right and also as far as the top four horizontal grid lines. It is you, and your laser cannon against various droids which rain down on you from the top of the grid. There are 20 zones (skill levels) and as you'd expect the further you progress the harder the game gets.

Laserzone is very much in the same style except in this one you actually are in control of two cannons, one going left to right, the other up and down the vertical axis. Again there are many aliens to master and thankfully there is a training mode which is highly recommended if you are to get very far in this one. There are again twenty levels of play and the real beauty of the game is that it allows two to play one controlling each cannon on the two axis which makes for quite an exciting game as you try as a team to defeat an excellent computer adversary.

Both games have stood the test of time and are excellent entertainment for the arcade fan. There is nothing comparable on the C16/Plus 4 which makes it highly recommended as far as originality. Of the two Matrix is slightly easier but the numerous levels are bound to keep even the most accomplished arcade player busy for many hours.

Frustrating, annoying, totally addictive!

#### MATRIX AND LASERZONE THE SCORES.

GRAPHICS	74%
PLAYABILITY	86%
ADDICTIVENESS	88%
LASTABILITY	89%
VALUE FOR MONEY	92%
H&D RATING	89%

Title Project Nova  
 Publisher Gremlin  
 Address Alpha House, 10 carver St, Sheffield, S1 4FS  
 R.R.P. 7.95  
 Game Type Arcade Strategy.

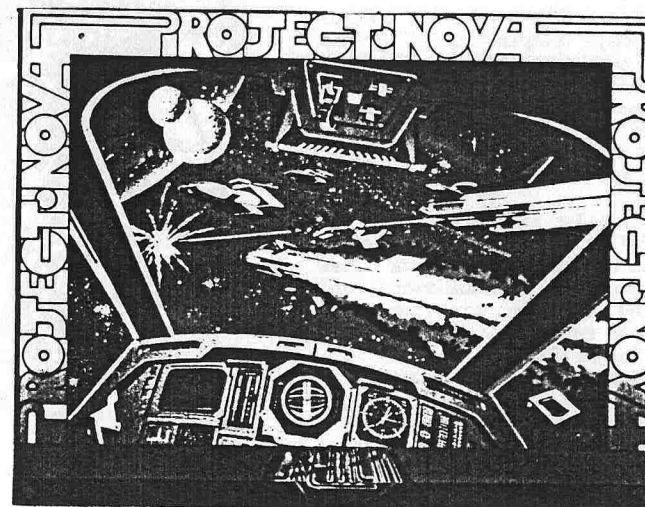
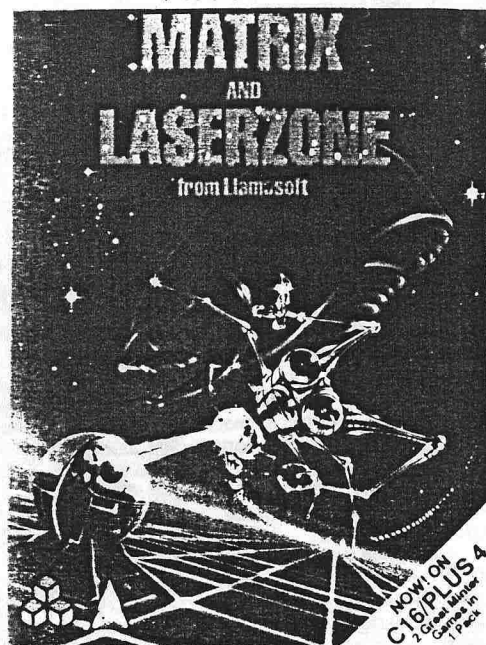

Gremlin have a good reputation for games on our machine and this certainly carries on the tradition although it is not for the faint hearted.

The game has you in the role of a Space Fighting Superstar, Master Technician, and Space Fleet Commander (Their words not ours). You must guide your ship on its mission to annihilate every alien in the galaxy.

The game consists of two displays. The cockpit view which gives an excellent being there feel as you fly amongst the stars. Above and below the screen you have your energy level, speed, rating, shield status, and ships computer. The ships computer takes you on to your second display which shows a layout of the galaxy and the number of aliens in the various quadrants plus the location of the all important energy quadrants where you pick up vital fuel.

The game requires more arcade skill than good strategy and all the mental skill in the world won't help if you can't blast those aliens. Energy has to be monitored very closely as using your shields, lasers, engines, or repairing your ship all use up valuable energy. There is a limited supply of fuel within the galaxy so you have to preserve your energy whenever possible. You have to be very careful when entering an alien quadrant as they are on to you very quickly, 100% shield power may protect you but just see those energy units zoom down. The longer you take to blast the aliens the more energy you burn up.

There are varying levels of play and as you'd expect the higher the level the more tough the going. The game boils down to a 3d Space Shoot 'em' up with the strategy element playing only a minor part. It is excellent but if your trigger finger is not up to scratch then it is probably advisable to steer clear. A little repetitive but a must for arcade fans.

#### PROJECT NOVA THE SCORES

GRAPHICS	78%
PLAYABILITY	86%
ADDICTIVENESS	85%
LASTABILITY	84%
VALUE FOR MONEY	86%
H&D RATING	85%

Title Leapin Louie  
 Publisher Audiogenic  
 R.R.P. 7.95  
 Game Type Arcade Platform

In this game you take on the role of Special Agent Louis Mooney (Leapin Louie to his friends) who has been captured by the evil forces of the Grong Empire and imprisoned in their ship. He must escape through ten rooms filled with booby traps and robot guards. To leave a room you must first collect six power batteries then enter a teleport to escape the room.

The game is very similar in style to Manic Miner but does fall short of that standard as far as content is concerned. Never the less the game is excellent entertainment and thought and timing are far more important than a quick arcade reflex so the game will appeal to a far larger audience.

The screens are not packed but graphically the game is nicely put together and is a joy to play. It is a great pity that there are only ten screens to master but at least they should be difficult enough to give you a few hours entertainment although at a £7.95 price tag the game is a little over priced.

#### Leapin Louie The Scores

GRAPHICS	78%
PLAYABILITY	84%
ADDICTIVENESS	81%
LASTABILITY	63%
VALUE FOR MONEY	75%
H&D RATING	77%

Title Tomb of Tarrabash  
 Publisher Audiogenic  
 R.R.P. 7.95  
 Game Type Arcade Adventure

You are the resourceful explorer Indiana Bloggs who has discovered a manuscript showing the whereabouts of the legendary treasure filled Tomb of Tarrabash. Your journey to Egypt and find the Pyramid that houses the tomb. The manuscript shows the tomb to be four levels down, but to your horror as soon as you start to enter the levels you discover all kinds of booby traps, dead ends, obstacles, Mummies and Deadly creatures that hinder your quest. It is going to be far from easy reaching that fourth level.

You start the game with three lives and only gain an extra life each time you complete a level. The screen shows only part of a level at any one time and as you move left and right and up and down stairs you can view four or five corridors at a time many of which contain apparently impassable obstacles



nearly all of which contain some evil looking creature. The game style is very reminiscent of Tom Thumb and offers a very similar style of challenge although Tom Thumb does appear at first sight to be superior as far as animation and content. Never the less Tomb of Tarrabash has a healthy game content and progression is far from easy and calls for a cool head as well as a quick joystick.

#### Tomb of Tarrabash The Scores

GRAPHICS	74%
PLAYABILITY	73%
ADDICTIVENESS	71%
LASTABILITY	68%
VALUE FOR MONEY	65%
H&D RATING	71%

Title Winter Events  
 Publisher Anco  
 Address 4 Westgate House, Spital St, Dartford, Kent.  
 R.R.P. 7.95



We may be nearing the end of a so called British Summer but here we have the eagerly awaited Winter Events which has had a few problems because of its similarity to the Winter Games from Epyx which for some reason did not go down too well with Epyx although they themselves had no plans to release a C16/Plus 4 version of their winter sport simulation. The similarity in presentation just goes to show the obvious skill that Anco have put into this version. Up to four players can take part and they can represent one of several countries. The six events within the game can all be either practiced or competed in. They are Biathlon, Slalom, Ski Jump, Speed skating, Bobsled, and Downhill.

## WINTER EVENTS BY UDO GERITZ

### MENU

Compete in all events  
 Compete in some events  
 Practice some events  
 See world records  
 Number of players: 1  
 Load/Save records

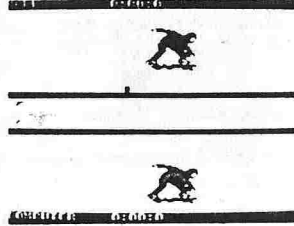
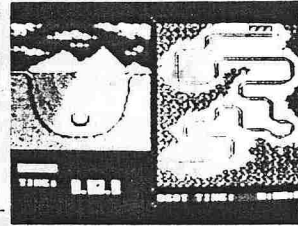
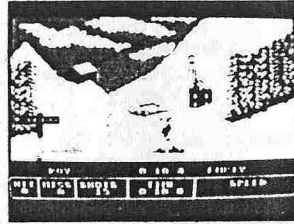
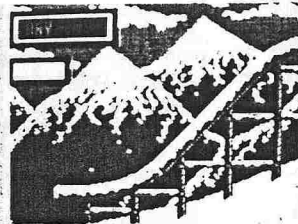

Unlike say Daley Thompsons Super Test this is not a joystick basher but events do call for timing and aggression. Graphically the game is excellent although the loading system is a bit of a pain. Each event is loaded seperately and there is a good deal of time spent waiting for events to load. Given the memory you cannot really complain on this point.

The game becomes more playable the more you have playing it although if playing by yourself some of the events do in the long run become a little monotonous and it is better to have that competitive edge when playing against friends. The medal ceremony at the end of each event is also a good laugh. There is no doubting the time and effort that has gone into the game but after a while the fun does begin to grow a little thin and it becomes a game that may get left to collect dust. £7.95 is an appropriate price tag for the effort taken over the game but unfortunately it is a little too much to ask, for a game that looks nice but does not promise long term playability. Do not buy on the basis of pretty pictures.

### WINTER EVENTS THE SCORES

GRAPHICS	88%
PLAYABILITY	85%
ADDICTIVENESS	58%
LASTABILITY	54%
VALUE FOR MONEY	63%
H&D RATING	65%

Title Yie Ar Kung Fu  
 Publisher Imagine  
 Address 6 Central St,  
 Manchester, M2 5NS.  
 R.R.P. 7.95  
 Game Type Karate Simulation

Forget the Kung Fu kid, he has come of age in this Karate/Kung Fu simulation. You take on the role of Oolong in his quest to become a grand master in the ancient skills of his father a Kung Fu master before him. You must face eight opponents each more deadly than the last with their own differing skill levels and weapons. All you have are 6 attack moves that you will have to master to defeat your opponents.

You and your opponent have a K.O. meter and if it reaches zero it results in a knock down. The eight opponents are loaded in two parts. You load in the first four and if you are able to defeat them you can then load in the remaining four opponents. There is a tendency to just waggle your joystick wildly and although you are able to defeat some opponents in this way, to

really get the most from the game and progress you do have to work out a strategy of attack. Although there are 6 possible attack moves you can usually get through each of your opponents by becoming proficient in only one or two of the moves at a time. It is indeed not easy to master all moves quickly and this will take time and patience although it would certainly give you far more satisfaction when playing the game.

One criticism of the game is the size of the characters which when compared to other formats are very small and as such you lose a little of the detail during the fight sequence.

The game is an excellent 'beat em' up but there has to be a question mark over lastability which is common in a one player game of this style. Once you have beaten opponents there is no real incentive to go back time and time again to fight again.

A good conversion but lacks a little on the game playing content, take a look before committing yourself to buying.

### Yie Ar Kung Fu The Scores

GRAPHICS	68%
PLAYABILITY	72%
ADDICTIVENESS	65%
LASTABILITY	48%
VALUE FOR MONEY	64%
H&D RATING	64%



Title The Second City  
 Publisher Novagen  
 R.R.P. 5.95  
 Game Type Arcade Strategy

What a treat for Plus 4 owners, following fast on the heels of the excellent Mercenary which we reviewed last issue we have the extension to the game in 'Second City'.

The game itself can only be played if you have already in your possession 'Mercenary' and the reduced price tag reflects this. Second City gives a new backdrop to the Palyar / Mechanoid conflict and all that you have learnt from Mercenary will be of only limited use in this godforsaken part of Targ. Your escape from Targ that appeared imminent in Mercenary has now been jeopardised by The Second City.

If you enjoyed Mercenary then this is the ideal purchase and is bound to give many more hours of challenging play. At £5.95 it is a little over priced but still a must for Mercenary fans.

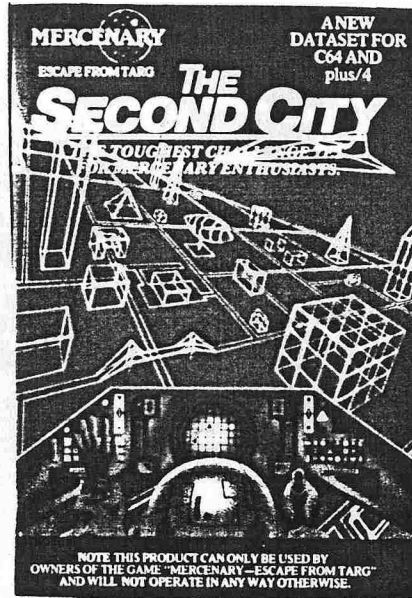

#### THE SECOND CITY THE SCORES

GRAPHICS	84%
PLAYABILITY	86%
ADDICTIVENESS	87%
LASTABILITY	81%
VALUE FOR MONEY	75%
H&D RATING	82%

#### BACK ISSUES

Issues 1 to 4 of this handbook are available at £1 each.

#### SEND ALL CORRESPONDENCE TO:

H&D SERVICES  
 1338, ASHTON OLD ROAD  
 HIGHER OPENSHAW  
 MANCHESTER  
 M11 1JG

\*\*\*\*\*

ISSUE 6 OF THE C16/PLUS 4 HANDBOOK

AVAILABLE FROM OCTOBER 20TH

DON'T MISS IT!

\*\*\*\*\*